

STEP 9

YOU WILL NEED:

4 x H8	16mm 
--------	---



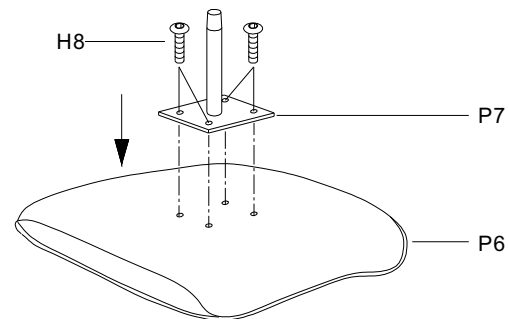

1 x ALLEN KEY (4MM)
(PROVIDED)



STEP 10

YOU WILL NEED:

1 X H9	
1 X H10	64mm 

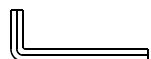

1 x ALLEN KEY (4MM)
(PROVIDED)

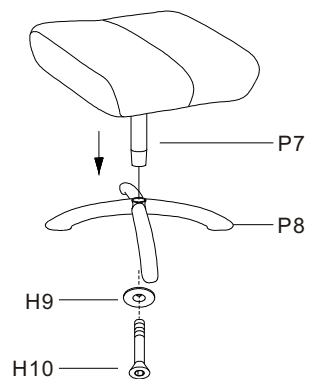

STEP 11

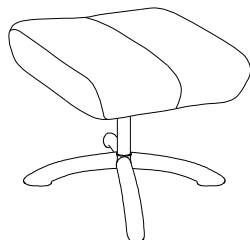

THE JOB IS COMPLETE!
IN THE INTEREST OF OUR ENVIRONMENT
PLEASE DISPOSE OF ALL PACKAGING THOUGHTFULLY.

Assembly Instructions

MONTREAL Recliner and Footstool



WARNING

FAILURE TO FOLLOW THESE BASIC STEPS CAN LEAD TO DAMAGE THAT IS NOT COVERED BY YOUR WARRANTY

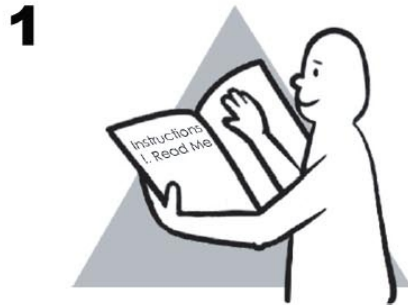

Read Instructions carefully. Check no parts are missing.

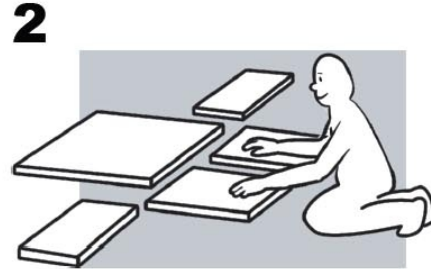

Lay out all of the components on a soft surface as if you were preparing to do a jigsaw puzzle.

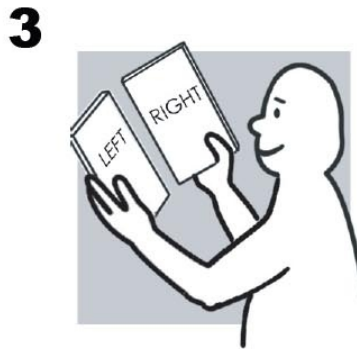

Carefully identify each component, especially those that are similar. The most common mistake is getting things back to front.



Separate and identify each component from the hardware pack and rest each one in its proper location before fastening.

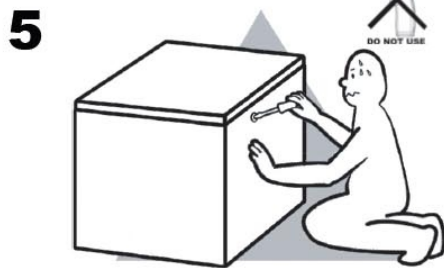

DO NOT fully tighten screws (leave slightly loose). When the item is fully assembled tighten the screws - but do not over tighten.

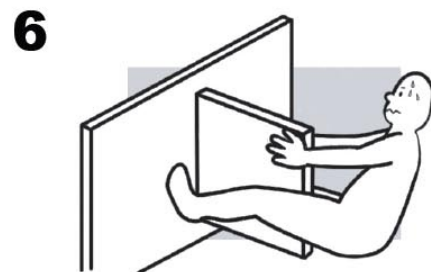

If glue is required **DO NOT** set until you are certain that the parts belong together.

STEP 7

YOU WILL NEED:

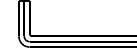

1 x ALLEN KEY (5MM)
(PROVIDED)



Tighten the screws

STEP 8





THE JOB IS COMPLETE!

IN THE INTEREST OF OUR ENVIRONMENT
PLEASE DISPOSE OF ALL PACKAGING THOUGHTFULLY.

STEP 5

YOU WILL NEED:

2 x H6	
2 x H7	



Please ensure there are two people to handle this product safely.

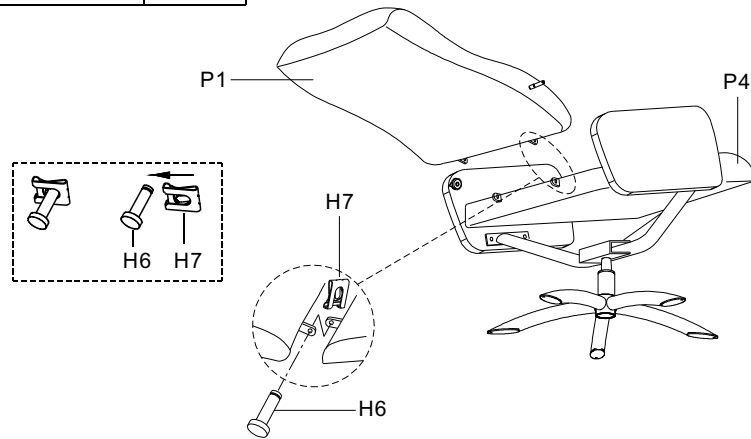

STEP 6



Please ensure there are two people to handle this product safely.

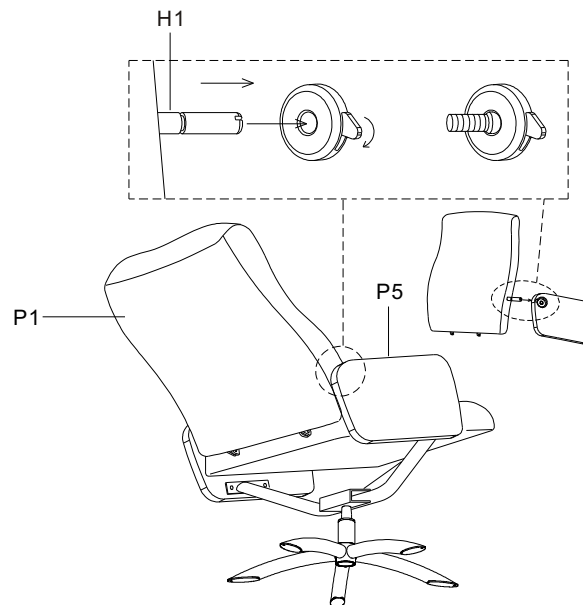

WHAT YOU NEED

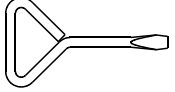

1 x ALLEN KEY (4MM)
(PROVIDED)

1 x ALLEN KEY (5MM)
(PROVIDED)

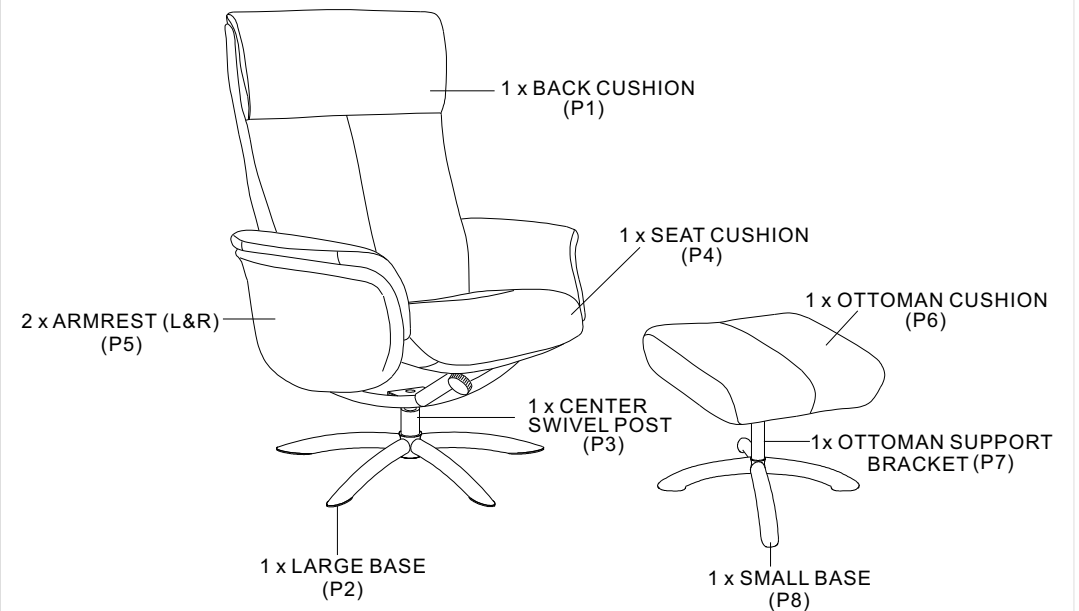

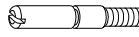
1 x SCREWDRIVER
(PROVIDED)





2 x RODS
(H1)

1 x SCREWS(28mm)
(H2)



1 x LARGE WASHER
(H3)



1 x NUT
(H4)



4 x SCREWS(27mm)
(H5)

2 x LOCK PINS
(H6)



2 x CLIPS
(H7)



4 x SCREWS(16mm)
(H8)

5 x SMALL WASHER
(H9)



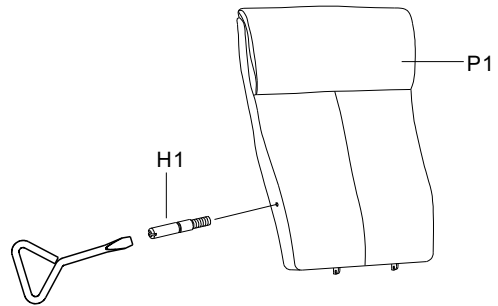
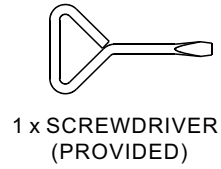

1 x SCREWS(64mm)
(H10)

STEP 1

YOU WILL NEED:	
2 x H1	



STEP 2

YOU WILL NEED:	
1 X H2	28mm 
1 X H3	
1 X H4	

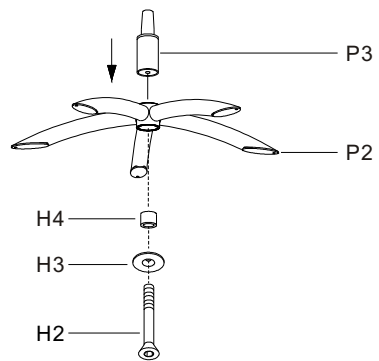
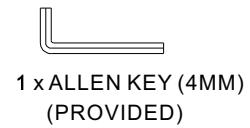

STEP 3

YOU WILL NEED:	
4 x H5	27mm 

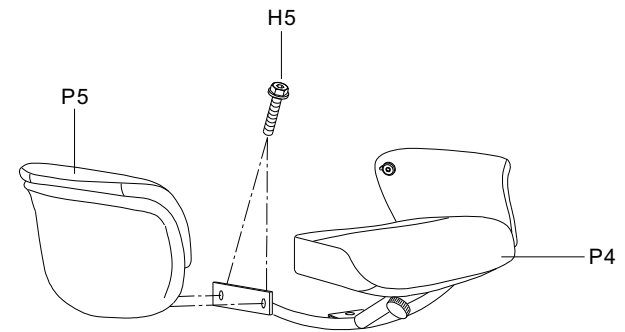
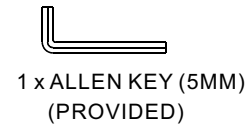

Do not tighten the screws

STEP 4



Please ensure there are two people to handle this product safely.

