

Assembly Instructions

TULIPS

DINING TABLE-E171

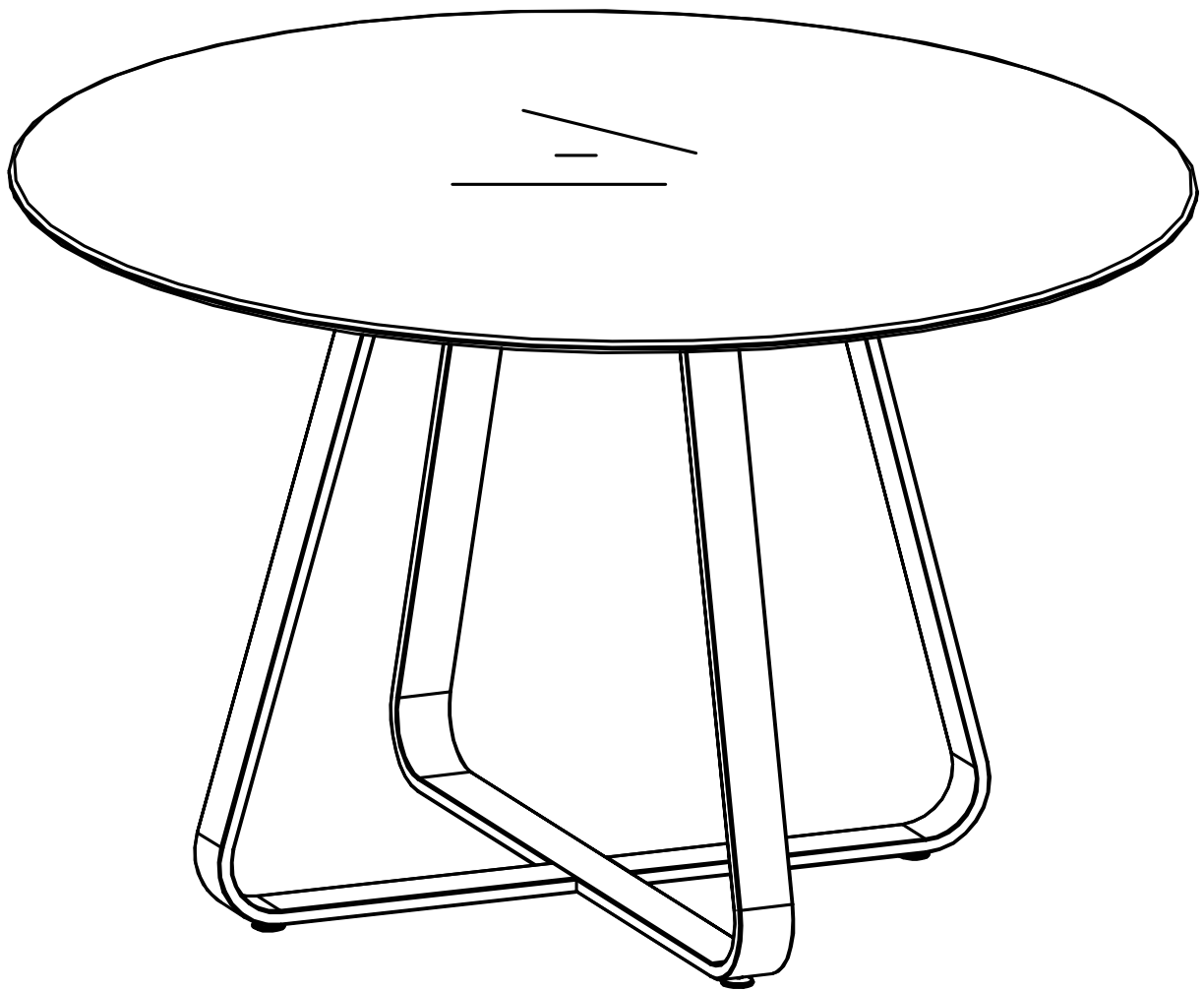

WARNING

FAILURE TO FOLLOW THESE BASIC STEPS CAN LEAD TO DAMAGE THAT IS NOT COVERED BY YOUR WARRANTY

1



Read Instructions carefully.
Check no parts are missing.

2

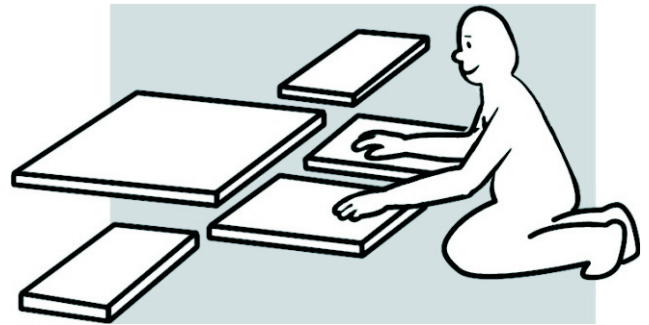

Lay out all of the components on a soft surface as if you were preparing to do a jigsaw puzzle.

3



Carefully identify each component, especially those that are similar. The most common mistake is getting things back to front.

4

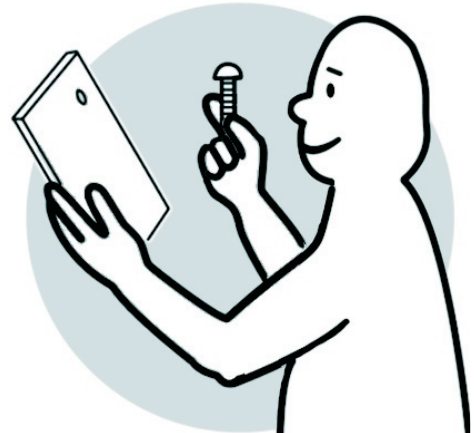

Separate and identify each component from the hardware pack and rest each one in its proper location before fastening.

5

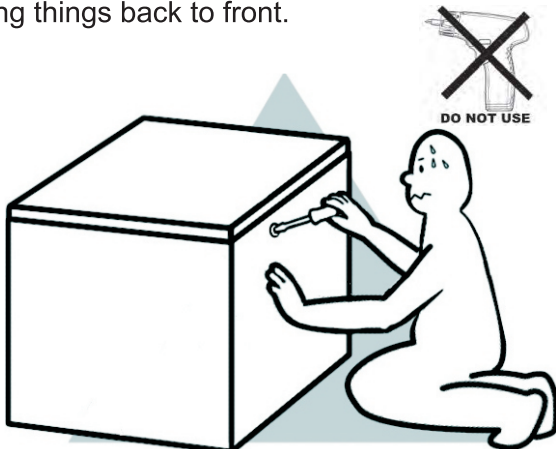

DO NOT fully tighten screws (leave slightly loose). When the item is fully assembled tighten the screws - but do not over tighten.

6

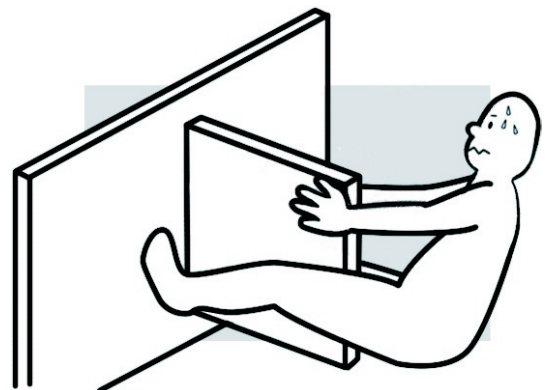

If glue is required **DO NOT** set until you are certain that the parts belong together.

What you Need



1 X Allen Key 5mm
(Provided)

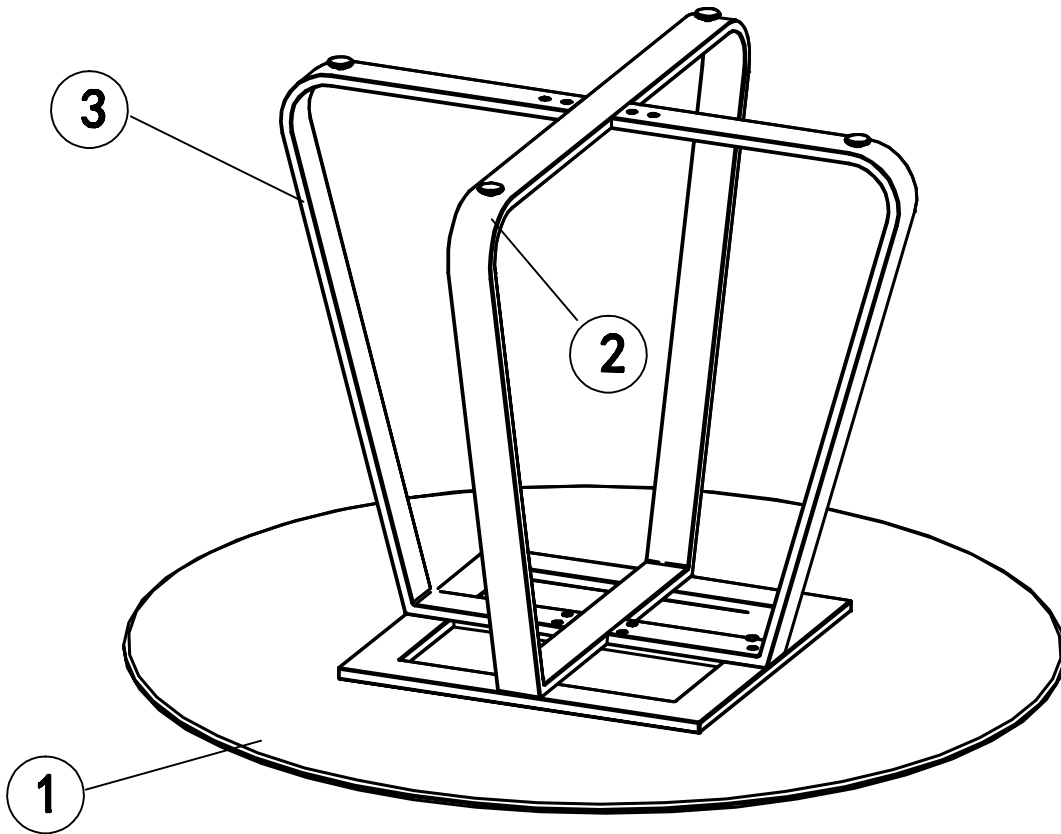



(A) M8*12 8PCS	(B) 8*16*1.5 12PCS	(C) M8*25 4PCS	(D) M8 4PCS

STEP 1



1XAllen Key 5MM

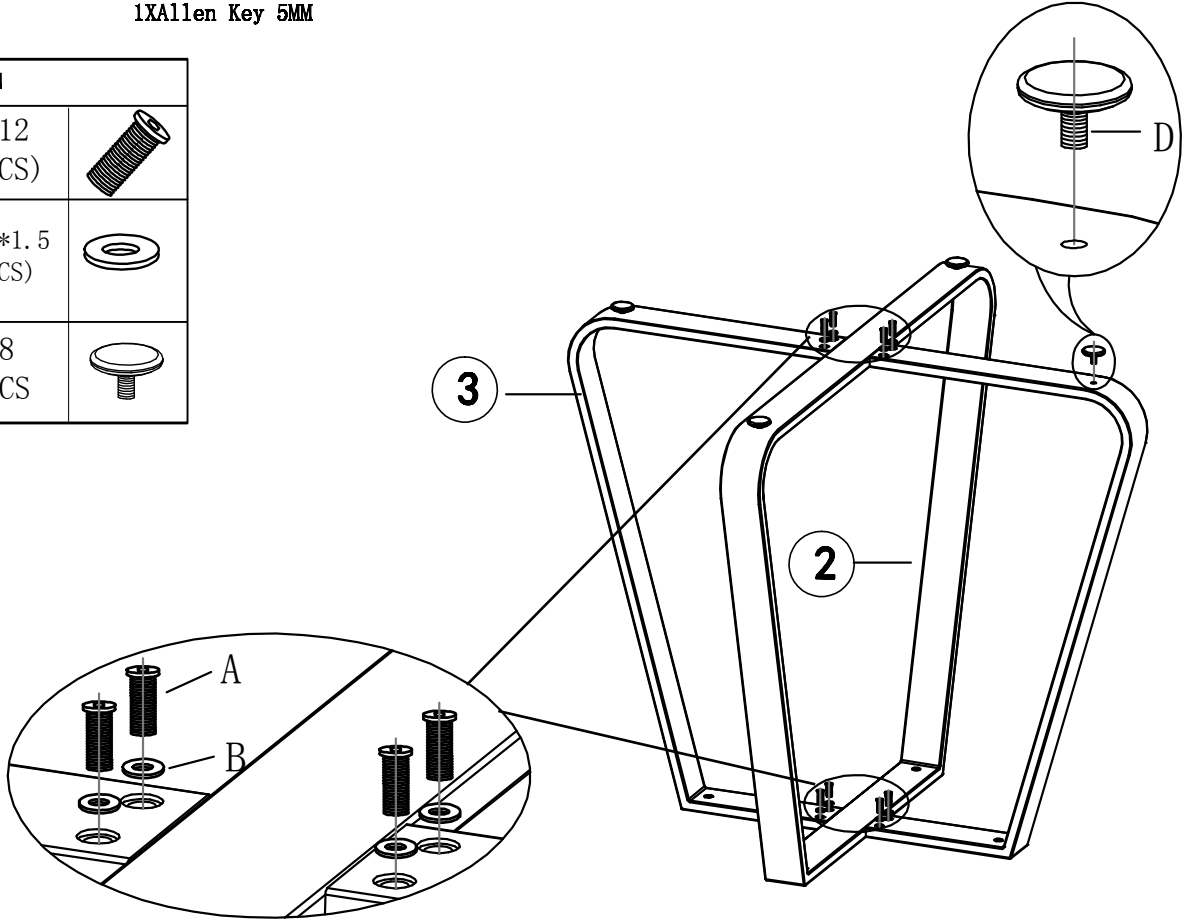

YOU Will Need		
A	8*12 (8PCS)	
B	8*16*1.5 (8PCS)	
D	M8 4PCS	



STEP 2



1 X Allen Key 5mm
(Provided)

YOU Will Need		
C	8*25 (4PCS)	
B	8*16*1.5 (4PCS)	

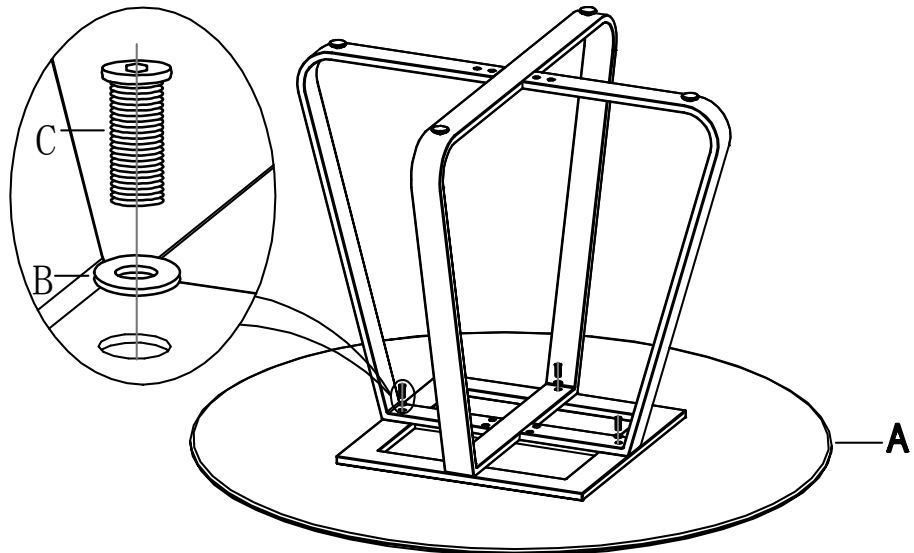

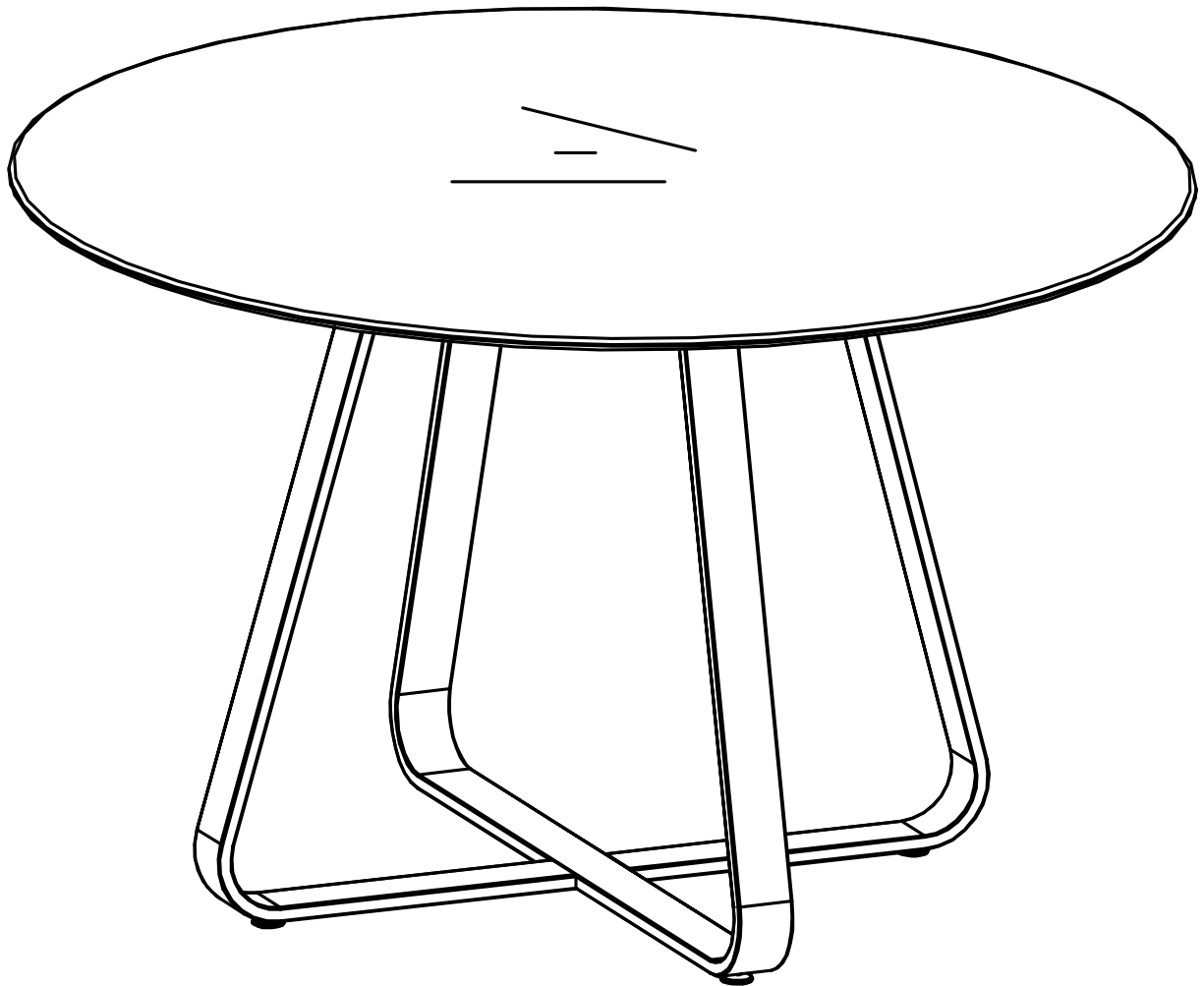

The job is now complete!

**In the interest of our environment
Please dispose of all packaging thoughtfully**