





# ASSEMBLY INSTRUCTIONS

## MODEL : ZARA COFFEE TABLE

### IMPORTANT NOTE :

- \* PLACE ALL WOODEN PARTS ON A CLEAN AND SMOOTH SURFACE SUCH AS A RUG OR CARPET TO AVOID THE PARTS FROM BEING SCRATCHED.
- \* BEFORE YOU BEGIN, KINDLY FOLLOW THE ASSEMBLY INSTRUCTIONS STEP BY STEP.

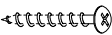
| HARDWARE LIST |   |      |
|---------------|---|------|
| A             | JCBC SCREW M6 x 70mm<br>   | 8PCS |
| B             | SPRING WASHER M6<br>       | 8PCS |
| C             | FLAT WASHER M6<br>         | 8PCS |
| D             | ALLEN KEY M4<br>           | 1PC  |
| E             | PH C/B SCREW #8 x 32mm<br> | 4PCS |

| PART LIST |           |      |
|-----------|-----------|------|
| 1         | TABLE TOP | 1PC  |
| 2         | TABLE LEG | 4PCS |

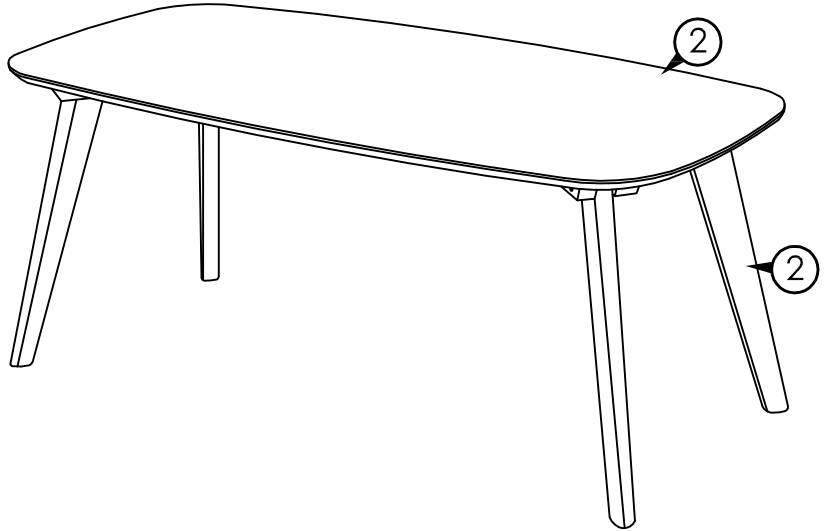

COMPLETED TABLE ASSEMBLY.

### STEP 1

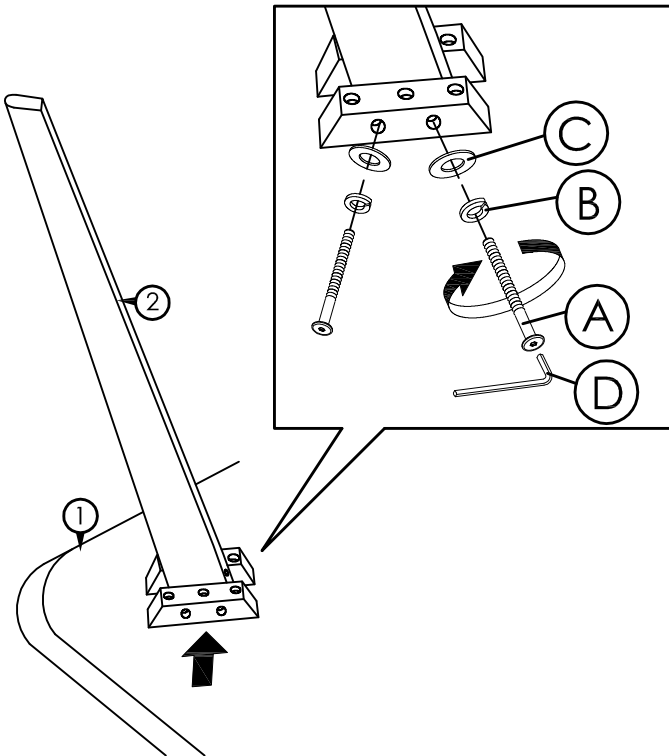

### STEP 2

